



Features

- Split Gate Trench MOSFET technology
- Excellent package for heat dissipation
- High density cell design for low $R_{DS(ON)}$

Product Summary

BVDSS	RDSON	ID
-60V	9.0mΩ	-80A

Applications

- Battery switching application
- Hard switched and high frequency circuits
- Power management

TO252 Pin Configuration

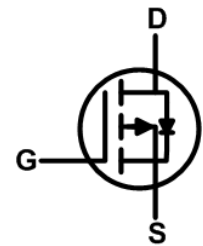
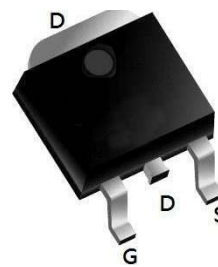

Absolute Maximum Ratings ($T_j = 25^\circ\text{C}$ unless otherwise specified):

Symbol	Parameter	Value	Units
V_{DSS}	Drain-to-Source Voltage	-60	V
I_D	Continuous Drain Current	$T_C = 25^\circ\text{C}$	-80
	Continuous Drain Current	$T_C = 100^\circ\text{C}$	-50
I_{DM}^{a1}	Pulsed Drain Current	-320	A
V_{GS}	Gate-to-Source Voltage	± 20	V
P_D	Power Dissipation	110	W
E_{AS}^{a2}	Single pulse avalanche energy	450	mJ
T_J, T_{stg}	Operating Junction and Storage Temperature Range	150, -55 to 150	$^\circ\text{C}$
T_L	Maximum Temperature for Soldering	300	$^\circ\text{C}$

Thermal Characteristics:

Symbol	Parameter	Value	Units
$R_{\theta JC}$	Thermal Resistance, Junction-to-Case	1.1	$^\circ\text{C}/\text{W}$
$R_{\theta JA}$	Thermal Resistance, Junction-to-Ambient	60	$^\circ\text{C}/\text{W}$

Static Characteristics						
Symbol	Parameter	Test Conditions	Value			Units
			Min.	Typ.	Max.	
V_{DSS}	Drain to Source Breakdown Voltage	$V_{GS}=0V, I_D=-250\mu A$	-60	--	--	V
I_{DSS}	Drain to Source Leakage Current	$V_{DS} = -60V, V_{GS}= 0V$	--	--	1	μA
$I_{GSS(F)}$	Gate to Source Forward Leakage	$V_{GS} = -20V$	--	--	100	nA
$I_{GSS(R)}$	Gate to Source Reverse Leakage	$V_{GS} = +20V$	--	--	-100	nA
$V_{GS(TH)}$	Gate Threshold Voltage	$V_{DS}=V_{GS}, I_D=-250\mu A$	-1.3	-1.8	-2.3	V
$R_{DS(ON)1}$	Drain-to-Source On-Resistance	$V_{GS}=-10V, I_D=-20A$	--	9.0	11.0	m Ω
$R_{DS(ON)2}$	Drain-to-Source On-Resistance	$V_{GS}=-4.5V, I_D=-15A$	--	12.0	16.0	m Ω
g_{FS}	Forward Transconductance	$V_{DS}=-5V, I_D=-20A$	50	--	--	S

Dynamic Characteristics						
Symbol	Parameter	Test Conditions	Value			Units
			Min.	Typ.	Max.	
C_{iss}	Input Capacitance	$V_{GS}=0V$	--	3060	--	pF
C_{oss}	Output Capacitance	$V_{DS}=-30V$	--	620	--	
C_{riss}	Reverse Transfer Capacitance	$f=1.0MHz$	--	20	--	
R_g	Gate resistance	$V_{GS}=0V, V_{DS}$ Open	--	2.0	--	Ω

Resistive Switching Characteristics						
Symbol	Parameter	Test Conditions	Value			Units
			Min.	Typ.	Max.	
$t_{d(ON)}$	Turn-on Delay Time	$I_D=-20A, R_L=0.75\Omega$	--	4.5	--	ns
t_r	Rise Time	$V_{DS} = -30V$	--	2.5	--	
$t_{d(OFF)}$	Turn-Off Delay Time	$V_{GS} = -10V$	--	14.5	--	
t_f	Fall Time	$R_G = 3\Omega$	--	3.5	--	
Q_g	Total Gate Charge	$V_{GS}=-10V$	--	56	--	nC
Q_{gs}	Gate Source Charge	$V_{DS}=-30V$	--	11	--	
Q_{gd}	Gate Drain Charge	$I_D=-20A$	--	9	--	

Source-Drain Diode Characteristics						
Symbol	Parameter	Test Conditions	Value			Units
			Min.	Typ.	Max.	
I_S	Diode Forward Current	$T_C=25^\circ C$	--	--	-80	A
I_{SM}	Diode Pulse Current		--	--	-320	A
V_{SD}	Diode Forward Voltage	$I_S=-6.0A, V_{GS}=0V$	--	--	-1.2	V
t_{rr}	Reverse Recovery time	$I_S=-20A, V_{DD}=-30V$	--	60	--	ns
Q_{rr}	Reverse Recovery Charge	$dI/dt=100A/\mu s$	--	105	--	nC

a¹: Repetitive rating; pulse width limited by maximum junction temperature

a²: $V_{DD} = 30V, L=0.3mH, R_G = 25\Omega, \text{Starting } T_j=25^\circ C$

Characteristics Curve:
Typ. output characteristics

$$I_D = f(V_{DS})$$

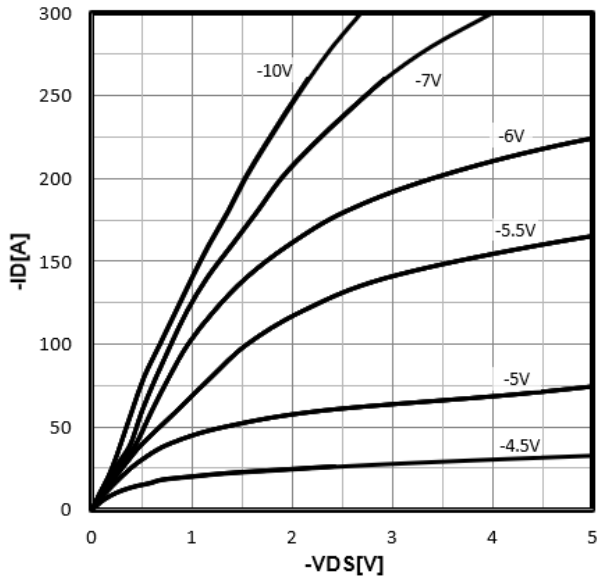
Typ. drain-source on resistance

$$R_{DS(on)} = f(I_D)$$

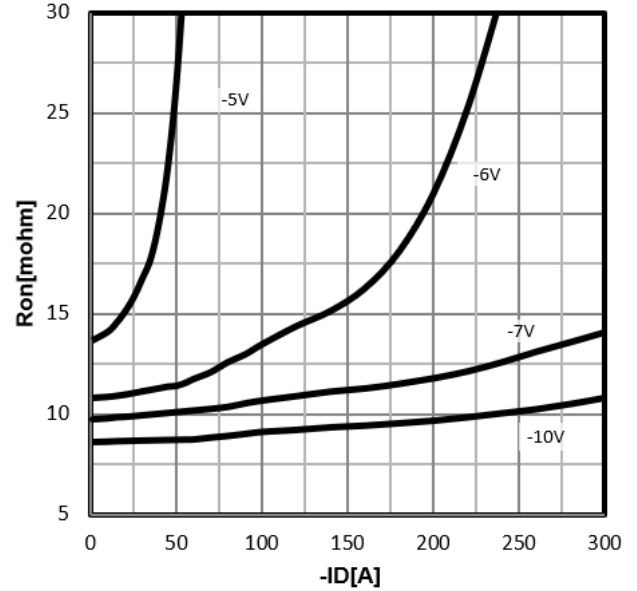
Typ. transfer characteristics

$$I_D = f(V_{GS})$$

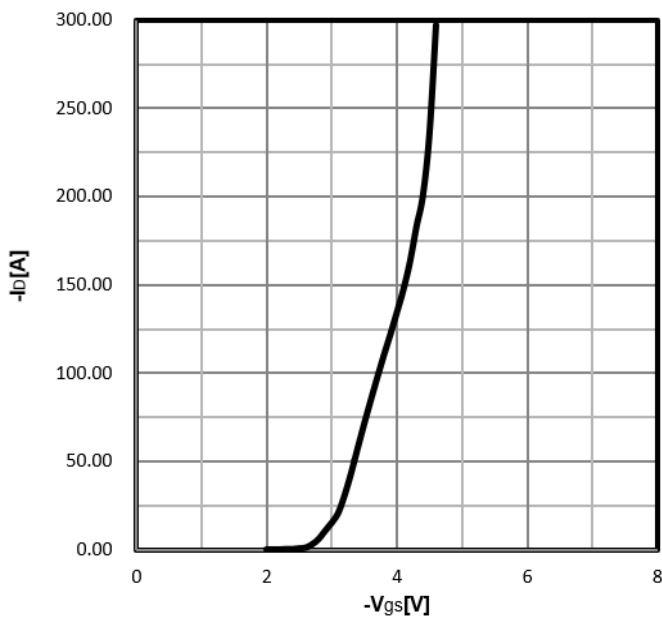

Typ. forward transconductance

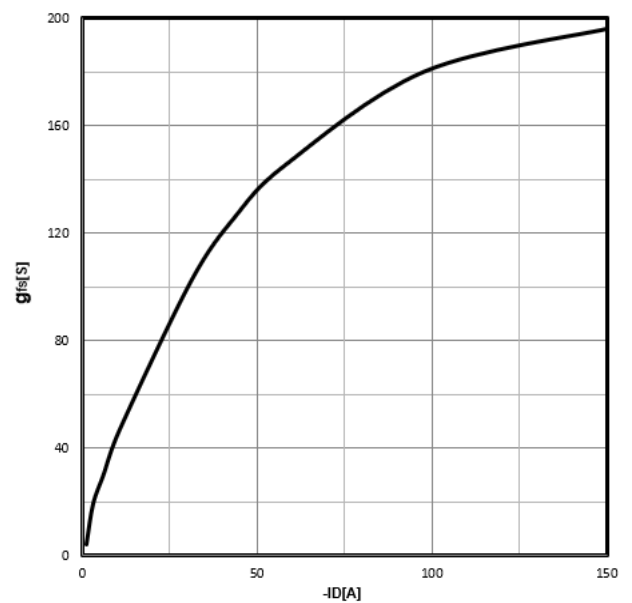
$$g_{fs} = f(I_D)$$

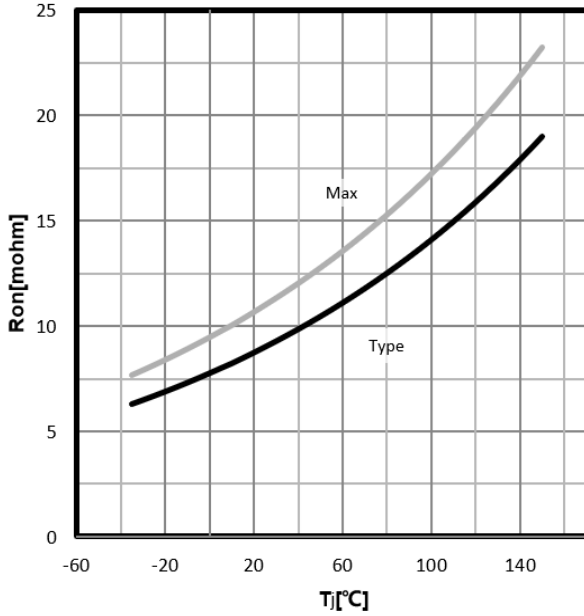

Drain-source on-state resistance

$R_{DS(on)}=f(T_j); I_D=-20A; V_{GS}=-10V$



Typ. capacitances

$C=f(V_{DS}); V_{GS}=0V; f=1MHz$

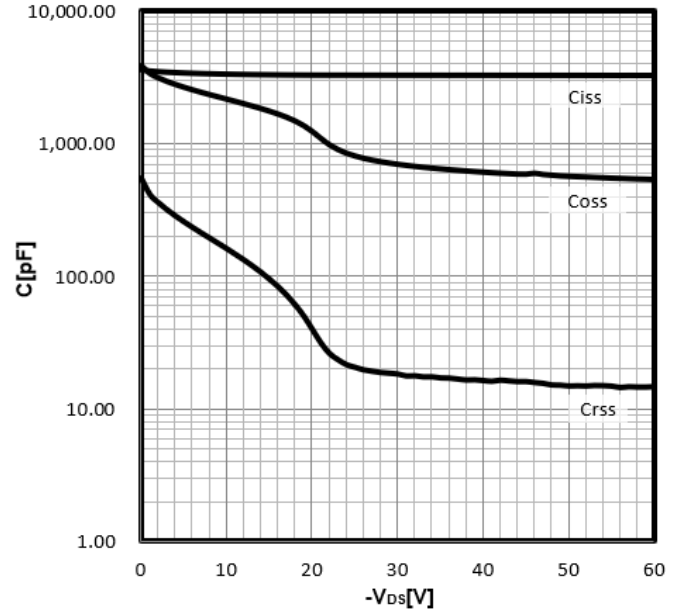

Typ. gate charge

$V_{GS}=f(Q_{gate}); I_D=-20A$

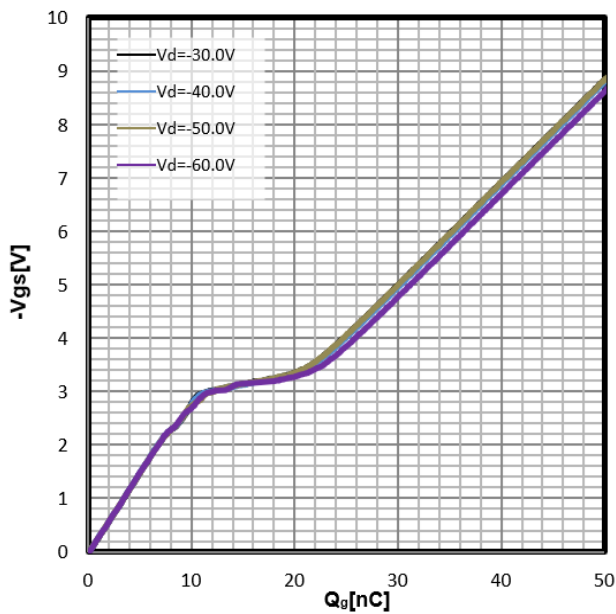

Drain-source breakdown voltage

$V_{BR(DSS)}=f(T_j); I_D=-250uA$

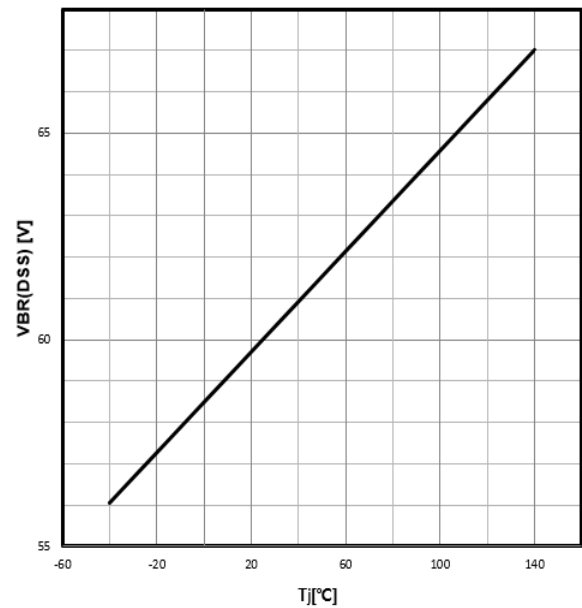

Power Dissipation

$$P_{tot}=f(T_c)$$

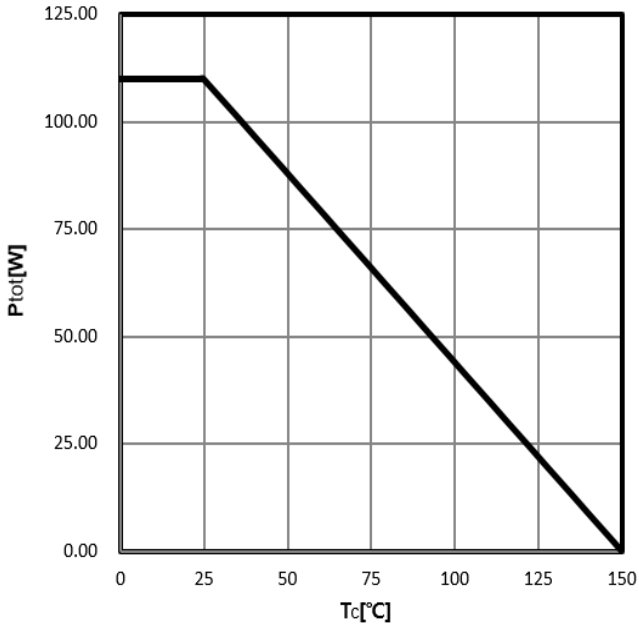

$$I_D=f(V_{DS})$$

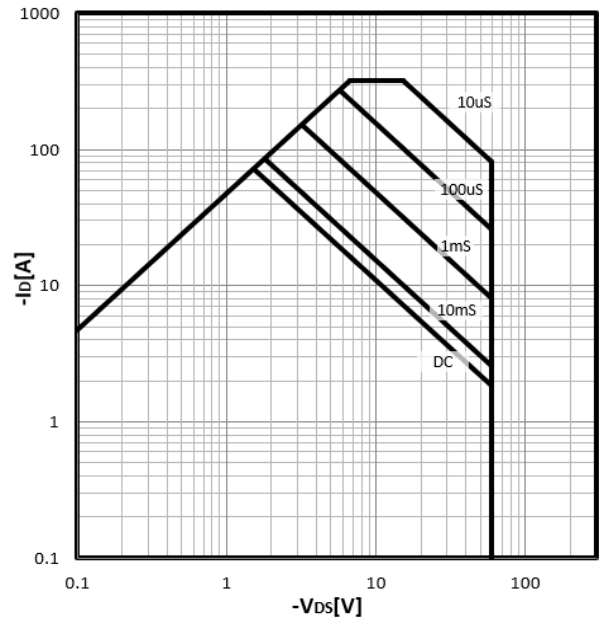

Max. transient thermal impedance

$$Z_{thJC}=f(t_p)$$

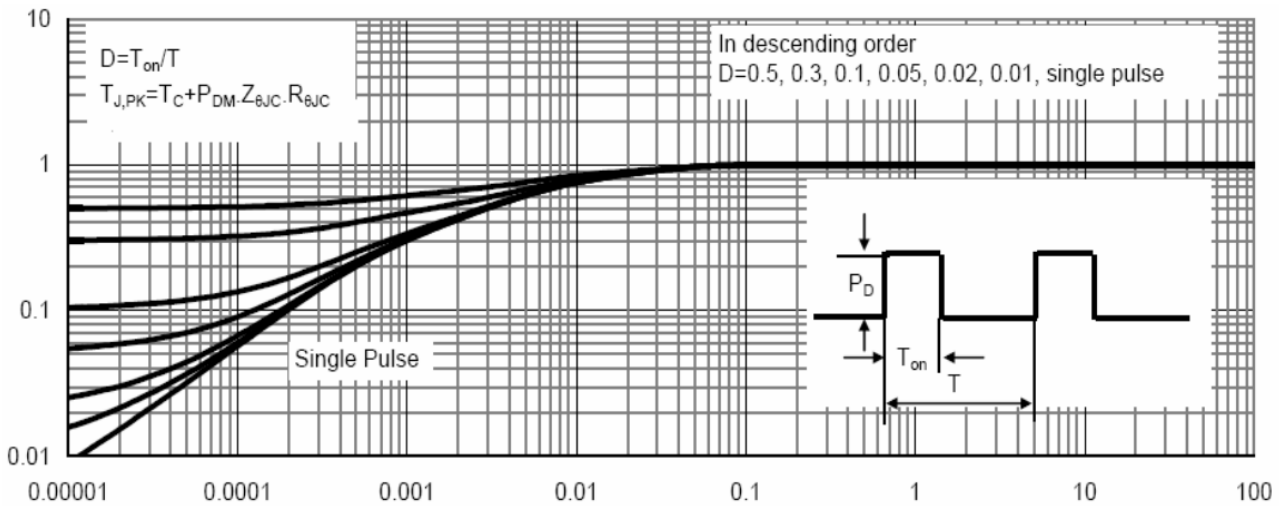

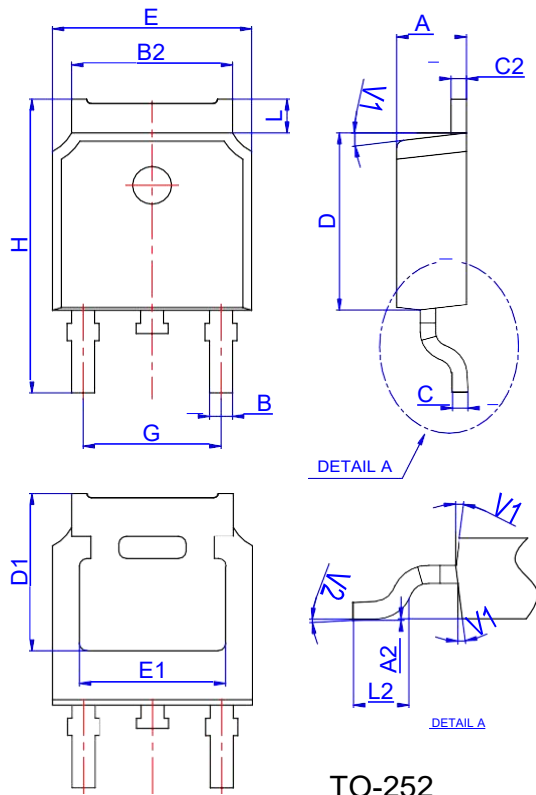
Package Mechanical Data-TO-252

Ref.	Dimensions					
	Millimeters			Inches		
	Min.	Typ.	Max.	Min.	Typ.	Max.
A	2.10		2.50	0.083		0.098
A2	0		0.10	0		0.004
B	0.66		0.86	0.026		0.034
B2	5.18		5.48	0.202		0.216
C	0.40		0.60	0.016		0.024
C2	0.44		0.58	0.017		0.023
D	5.90		6.30	0.232		0.248
D1	5.30REF			0.209REF		
E	6.40		6.80	0.252		0.268
E1	4.63			0.182		
G	4.47		4.67	0.176		0.184
H	9.50		10.70	0.374		0.421
L	1.09		1.21	0.043		0.048
L2	1.35		1.65	0.053		0.065
V1		7°			7°	
V2	0°		6°	0°		6°

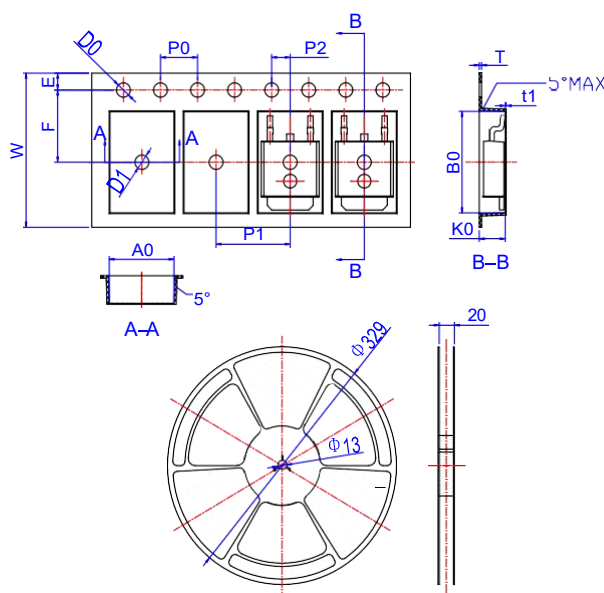
Reel Specification-TO-252-4R

Ref.	Dimensions					
	Millimeters			Inches		
	Min.	Typ.	Max.	Min.	Typ.	Max.
W	15.90	16.00	16.10	0.626	0.630	0.634
E	1.65	1.75	1.85	0.065	0.069	0.073
F	7.40	7.50	7.60	0.291	0.295	0.299
D0	1.40	1.50	1.60	0.055	0.059	0.063
D1	1.40	1.50	1.60	0.055	0.059	0.063
P0	3.90	4.00	4.10	0.154	0.157	0.161
P1	7.90	8.00	8.10	0.311	0.315	0.319
P2	1.90	2.00	2.10	0.075	0.079	0.083
A0	6.85	6.90	7.00	0.270	0.271	0.276
B0	10.45	10.50	10.60	0.411	0.413	0.417
K0	2.68	2.78	2.88	0.105	0.109	0.113
T	0.24		0.27	0.009		0.011
t1	0.10			0.004		
10P0	39.80	40.00	40.20	1.567	1.575	1.583